

(19)



Europäisches Patentamt  
European Patent Office  
Office européen des brevets



(11)

**EP 1 437 101 A2**

(12)

**EUROPEAN PATENT APPLICATION**

(43) Date of publication:  
**14.07.2004 Bulletin 2004/29**

(51) Int Cl.7: **A61F 2/08, A61F 2/44**

(21) Application number: **03258243.9**

(22) Date of filing: **30.12.2003**

(84) Designated Contracting States:  
**AT BE BG CH CY CZ DE DK EE ES FI FR GB GR  
HU IE IT LI LU MC NL PT RO SE SI SK TR**  
Designated Extension States:  
**AL LT LV MK**

• **Serhan, Hassan A.**  
**South Easton, MA 02375 (US)**  
• **Garcia, Mark**  
**Rochester, MA 02770 (US)**

(30) Priority: **31.12.2002 US 334601**

(74) Representative: **Belcher, Simon James**  
**Urquhart-Dykes & Lord LLP**  
**Tower House,**  
**Merrion Way**  
**Leeds LS2 8PA (GB)**

(71) Applicant: **DePuy AcroMed, Inc.**  
**Raynham, MA 02767 (US)**

(72) Inventors:  
• **Dooris, Andrew**  
**Fall River, MA 02720 (US)**

(54) **Prosthetic facet joint ligament**

(57) A facet joint prosthesis for replacing a natural facet joint comprising first and second facets, comprises a superior facet joint component having a superior outer surface adapted to attach to a superior facet, an inferior

facet joint component having an inferior outer surface adapted to attach to an inferior facet, and a ligament adapted to constrain relative movement between the facets.

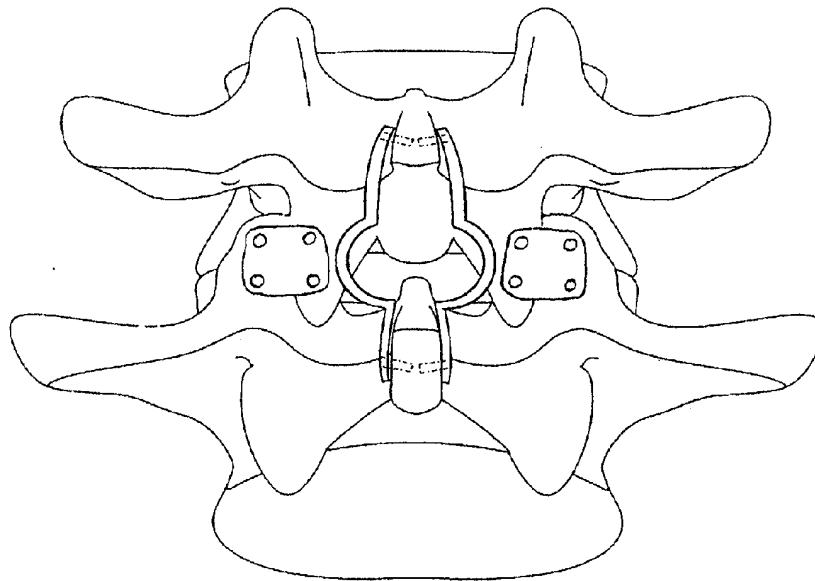

**FIG. 15**

**EP 1 437 101 A2**

## Description

**[0001]** This invention relates to a prosthetic facet joint ligament.

**[0002]** One of the most common surgical interventions today is arthrodesis, or spine fusion, in which two or more adjacent vertebral bodies are fused together in order to alleviate pain associated with the disc(s) located between those vertebral bodies. Approximately 300,000 such procedures are performed annually in the United States alone. Clinical success varies considerably, depending upon technique and indications, and consideration must be given to the concomitant risks and complications.

**[0003]** While spine fusion generally helps to eliminate certain types of pain, it has also been shown to decrease function by limiting the range of motion for patients in flexion, extension, rotation and lateral bending. Furthermore, it is believed that spine fusion creates increased stresses on (and, therefore, accelerated degeneration of) adjacent non-fused motion segments. Additionally, pseudoarthrosis, resulting from an incomplete or ineffective fusion, may reduce or even totally eliminate the desired pain relief for the patient. Also, the fusion device (s) used to effect fusion, whether artificial or biological, may migrate out of the fusion site, thereby creating significant new problems for the patient. Lastly, the recuperation time after a fusion procedure can be lengthy.

**[0004]** Recently, several attempts have been made to recreate the natural biomechanics of the spine through the use of an artificial disc. Artificial discs are intended to restore articulation between vertebral bodies so as to recreate the full range of motion normally allowed by the elastic properties of the natural disc, which directly connects two opposed vertebral bodies. However, the artificial discs developed to date do not adequately address the mechanics of motion of the spinal column.

**[0005]** In addition to the foregoing, posterior elements called the facet joints help to support axial, torsional and shear loads that act on the spinal column. Furthermore, the facet joints are diarthroidal joints that provide both sliding articulation and load transmission features. The facet's articular surfaces contact in extension, limiting rotation and increasing compressive load. The articular surfaces also contact on one side of the spine in lateral bending and axial rotation, also limiting rotation and transferring load.

**[0006]** However, the facet joints can also be a significant source of spinal disorders and, in many cases, debilitating pain. The articular cartilaginous surfaces can degenerate due to mechanical or biological factors and cause pain as with other joint osteoarthritis. For example, a patient may suffer from arthritic facet joints, severe facet joint tropism or otherwise deformed facet joints, facet joint injuries, etc. There is currently a lack of suitable intervention procedures for facet joint disorders. Facetectomy, or the removal of the facet joints, may provide some relief, but is also believed to significantly de-

crease the stiffness of the spinal column (that is, hypermobility) in all planes of motion: flexion and extension, lateral bending, and rotation. Furthermore, problems with the facet joints can also complicate treatments associated with other portions of the spine. By way of example, contraindications for artificial discs include arthritic facet joints, absent facet joints, severe facet joint tropism or otherwise deformed facet joints. Accordingly, there is a need for a facet joint replacement that addresses these concerns.

**[0007]** US-Re-36758 (Fitz I) discloses an artificial facet joint where the inferior facet, the mating superior facet, or both, are simply covered with a cap. Because placement of the cap requires no preparation of the bone or articular surfaces; it covers and, therefore, preserves the bony and articular structures.

**[0008]** However, simple capping of the facet has several potential disadvantages. If the facet joint is osteoarthritic, a cap will not remove the source of the pain. Additionally, at least in the case of surface replacements for osteoarthritic femoral heads, the capping of articular bone ends has proven to lead to clinical failure due to mechanical loosening. This clinical failure is hypothesized to be a consequence of disrupting the periosteum and ligamentum teres femoris, both of which play a role in delivering nutrition to the femoral head, thereby leading to avascular necrosis of the bony support structure for the surface replacement. It is possible that corresponding problems could develop from capping the facet. Another potential disadvantage of facet capping is that in order to accommodate the wide variability in anatomical morphology of the facets, not only between individuals but also between levels within the spinal column, as well as due to associated hypertrophic and degenerative changes, a very wide range of cap sizes and shapes is required.

**[0009]** US-6280444 (Zuchermann) discloses a spacer that is wedged between the spinous processes, a spinal extension stop, and methods to implant it. According to Zuchermann, the spacer limits rotation in extension while providing flexion mobility. This document discloses a method to reduce stenosis by increasing posterior disc height and limiting extension. However, it is unknown exactly what function such a device would have. This device may abnormally loads the spinous processes and therefore could lead to abnormal bone remodeling. It affects the posterior elements and provides mobility, but does not alleviate posterior structures or address facet syndromes.

**[0010]** US-6132464 (Martin) describes a replacement of the articular surfaces and means for supporting and fixing these replacements to the posterior processes. The articulating surface itself is described as having "the shape, position, and orientation of a natural articular facet". It discloses a spinal facet joint prosthesis that is supported on the lamina (which is sometimes also referred to as the posterior arch). Extending from this support structure are inferior and/or superior blades that replace

the cartilage at the facet joint. The prosthesis disclosed in this document generally preserves existing bony structures and therefore does not address pathologies which affect the bone of the facets in addition to affecting the associated cartilage. Furthermore, the disclosed prosthesis requires a secure mating between the prosthesis and the lamina. However, the lamina is a very complex and highly variable anatomical surface. As a result, in practice, it is very difficult to design a prosthesis that provides reproducible positioning against the lamina so as to correctly locate the cartilage-replacing blades for the facet joints.

**[0011]** US-6132464 discloses articular surfaces and means of attachment, but does not describe a capsular replacement.

**[0012]** US-5571191 (Fitz II) describes a facet prosthesis comprising superior and inferior components, pyramidal or conical in shape, fitting over the facet processes, and having low friction mating surfaces. Although this document describes articular surfaces and means of attachment, it does not describe a capsular replacement.

**[0013]** Gardner et al. *Eur. Spine J* (2002) (Supp 2): S 157-163, discloses Graf ligamentoplasty as a means of stabilizing and reducing mobility of one or more severely symptomatic motion segments associated with degenerative disc disease. Fig. 1 shows Polyester bands wrapped around a pair of pedicle screws extending from adjacent vertebral bodies. According to Gardner, appropriate Graf bands immobilizes the motion segment in lordosis with the facet joints in a position of full extension, in which position they are very stable (see page S 159). Accordingly, Graf ligamentoplasty essentially immobilizes the facet joint. Gardner does not disclose a ligament that traverses a facet joint.

**[0014]** Senegas et al., *Eur. Spine J.* (2002) 11 (Supp 2): S164-9 discloses a Wallis implant system comprising a titanium interspinous blocker and a Dacron ligament, wherein the blocker is placed between two spinous processes and the Dacron ligament wraps around spinous processes. See p. S165. Accordingly, Senegas does not disclose a ligament that traverses a facet joint.

**[0015]** WO-00/53126 (Ogun) discloses a memory metal implant for fixing an articulated joint, including a facet joint.

**[0016]** The Dynasis system is generally used as a replacement for the natural posterior longitudinal ligament. The system includes a cable housed inside a plastic sheath, and is attached to superior and inferior pedicles. The ligament of the Dynasis system does not traverse a facet joint.

**[0017]** According to the present invention, it has been recognised that natural facet joints are true articulating joints in which the capsule surrounding the articular surfaces play a very important role. While the articular surface of the joint transfers compression, the capsule transfers tension. In flexion, the joint opens and the capsule is stretched. Several biomechanical *in vitro* studies

have demonstrated the contribution of the capsule to total motion segment stiffness in flexion.

**[0018]** Replacing the articular surface may relieve pain, but does not fully restore joint functionality.

**[0019]** Accordingly, it has been recognised a need for stabilizing the facet joint in both compression and tension, and for preventing proliferation of debris from the implant site to the surrounding tissues.

**[0020]** In one aspect of the present invention, the facet joint is stabilised in both compression and tension by a prosthetic ligament having fasteners fixated either in the superior and inferior vertebrae or in superior and inferior prosthetic facet joint components. In some embodiments, the fasteners are selected from the group consisting of bone screws, hooks, wires, and pins. In some embodiments, the intermediate portion of the ligament is selected from the group consisting of a cable, a wires, an interconnected face, and a soft polymer bonded to the fastener and stretching between the superior and inferior fastener.

**[0021]** Accordingly, the present invention replaces the natural facet joint capsule with an artificial construct that more fully provides the natural mechanical relationship provided by a natural healthy facet joint. In particular, by providing a ligament that stretches while resisting tension increases joint stability, the present invention more closely simulates physiological contributions of the facet joint capsule and so more closely approximates a full natural facet joint.

**[0022]** In one aspect of the present invention there is provided a prosthetic facet joint ligament. In preferred embodiments, this prosthetic facet joint ligament can be attached to anchoring points on opposing sides of a natural or prosthetic facet joint to provide a constraint against relative movement of the facet joints.

**[0023]** In a preferred embodiment of the present invention, the ligament is shaped as a sheath that can prevent debris produced by the facet articulation from spreading to the surrounding tissues, in particular to various neural structures. Previous facet joint replacement inventions describe resurfacing techniques that replace the contacting faces of the facet joint with metals or polymers. Due to unique variation in motions of the facet joint, these resurfaced contacting faces will inevitably produce wear debris, which is likely to irritate tissues. A membrane or sheath that surrounds the contacting faces and captures generated particles can reduce tissue irritation and inflammation. The membrane or sheath may also have structural integrity in itself and resist over-stretching and thereby supply resistance to tension.

**[0024]** In some embodiments, the prosthetic facet joint ligament is used in combination with other prosthetic facet joint components to produce a prosthetic facet joint having both load-bearing and movement-constraining functions.

**[0025]** Therefore, in accordance with the present invention, there is provided a prosthetic facet joint liga-

ment.

**[0026]** In some embodiments, the prosthetic facet joint is used in combination with intervertebral body components to produce a total vertebral solution addressing both anterior and posterior loading and movement issues.

**[0027]** Therefore, in accordance with the present invention, there is provided a facet joint prosthesis for replacing a natural facet joint comprising first and second facets, the prosthesis comprising:

- (a) a superior facet joint component having a superior outer surface adapted to attach to a superior facet,
- (b) an inferior facet joint component having an inferior outer surface adapted to attach to an inferior facet, and
- (c) a ligament adapted to constrain relative movement between the facets.

**[0028]** In another aspect, the invention provides a kit comprising a prosthetic facet joint component and an intervertebral body device.

**[0029]** Embodiments of the invention will now be described by way of example with reference to the accompanying drawings, in which:

FIG. 1 discloses a pair of facet joint ligaments of the present invention attached across a pair of facet joints of a functional spinal unit.

FIG. 2 discloses a pair of facet joint ligament of the present invention, wherein each ligament is a capsule, respectively, attached across a facet joint of the same functional spinal unit.

FIG. 3 discloses preferred embodiments of a facet joint ligament of the present invention.

FIG. 4 discloses a driver used to attach the facet joint ligament of FIG. 3

FIG. 5 discloses an embodiment of the ligament of the present invention comprising a curved, flexible intermediate portion attached across a facet joint.

FIG. 6 discloses an embodiment of the ligament of the present invention comprising a spring intermediate portion.

FIG. 7 discloses an embodiment of the ligament of the present invention comprising a pair of curved, flexible intermediate portions encapsulated in a polymer.

FIG. 8 discloses an embodiment of the ligament of the present invention comprising a pair of straight intermediate portions attached by a polymer

FIG. 9 discloses superior and inferior prosthetic facets having opposed articulating surfaces.

FIG. 10 discloses superior and inferior facets having a prosthetic cushion attached between them.

FIG. 11 discloses a pair of facet joint ligament of the present invention, wherein the ligament is a capsule, attached across a pair of facet joints of a func-

tional spinal unit having a fusion cage inserted therein.

FIG. 12 discloses a pair of facet joint ligament of the present invention, wherein the ligament is a capsule, attached across a pair of facet joints of a functional spinal unit having a three-piece motion disc inserted therein.

FIG. 13 discloses a pair of facet joint ligament of the present invention, wherein the ligament is a capsule, attached across a pair of facet joints of a functional spinal unit having a two-piece motion disc inserted therein.

FIG. 14 discloses a pair of facet joint ligament of the present invention, wherein the ligament is a capsule, attached across a pair of facet joints of a functional spinal unit having a cushion-type motion disc inserted therein.

FIG. 15 discloses an embodiment of the ligament of the present invention attached across a pair of spinous processes coupled with a prosthetic facet joint.

FIG. 16 discloses an embodiment of the ligament of the present invention wrapped around a facet joint.

**[0030]** Referring to the drawings, FIG.1 shows a first embodiment of the facet joint ligament 101 of the present invention. The ligament comprises first 103 and second 105 attachment end portions and an intermediate portion 107. The first attachment end portions attaches to the superior facet SF of the facet joint, while the second attachment end portion attaches to the inferior facet IF of the facet joint. Thus, the ligament traverses the facet joint.

**[0031]** Now referring to FIG.2, there is provided a second embodiment of the facet joint ligament of the present invention, wherein the ligament is a capsule 111 surrounding the facet joint The capsule comprises first 113 and second 115 attachment end portions and a sheath portion 117. The first attachment end portions attaches to the superior facet SF of the facet joint, while the second attachment end portion attaches to the inferior facet IF of the facet joint. The sheath traverses and completely circumscribes the facet joint. In this FIG. 2, the sheath may cover a portion of the exposed bony surface.

**[0032]** The ligament of the present invention can be made of any biocompatible material adapted for constraining but not totally eliminating relative movement between facet joints. In this regard, the facet joint ligament of the present invention mimics the natural facet joint capsule. The ligament of the present invention comprises three features. First it must be adapted to traverse a facet joint. Second, it must allow some flexion to occur across the facet joint. Third, it must resist excessive flexion of the facet joint.

**[0033]** In preferred embodiments, the ligament comprises a pair of attachment end portions and an inter-

mediate portion.

**[0034]** Each attachment end portion of the ligament is adapted to attach to an anchoring surface on opposite sides of the facet joint. Typically, the attachment end portion comprises a fastener. In other cases, attachment may be provided by sutures or biologically compatible glues. However, in other embodiments, an attachment end portion can simply be terminus being identical in design to the intermediate portion. In such a case, the terminus is inserted into a port located on the anchoring surface, such as a port on a prosthetic having a facet joint articulating surface.

**[0035]** The intermediate portion of the ligament may be adapted to have desirable mechanical qualities found in ligaments, such as elasticity, flexibility, tension ability, and extensibility. Combinations of these qualities allows some displacement of the articular surfaces, but resists excessive displacement.

**[0036]** Preferably, the intermediate portion of the facet joint ligament is made from a non-bioresorbable material including polyesters, (particularly aromatic esters such as polyalkylene terephthalates, polyamides; polyalkenes; poly(vinyl fluoride); polyurethanes; polytetrafluoroethylene (PTFE); carbon fibres; silk; rubber, hydrogels, and glass, and mixtures thereof.

**[0037]** Preferably, the intermediate portion of the facet joint ligament is provided as a fabric. The fabric may be formed by a flat or circular weaving, knitting, braiding, crocheting or embroidery. Preferably, the fabric is braided in order to provide a high tensile strength. Preferred materials suitable for use as fabrics include polyester, polypropylene, polyethylene, carbon fibre, glass, glass fibre, polyurethane, polyaramide, metals, polymers, copolymers, polylactic acid (PLA), polyglycolic acid (PGA), silk, cellulosic acid, and polycaprolactone fibres.

**[0038]** It is anticipated that, in use, the intermediate portion of the facet joint ligament may rub against soft tissue structures and damage not only those structures but itself as well. Therefore, in some embodiments, the intermediate portion of the facet joint ligament is lubricated. The lubricants lowers the friction coefficient between the ligament and the soft tissue, thereby lowering the wear. Preferred lubricants include hyaluronic acid, proteoglycans, and hydrogels

**[0039]** In some embodiments, the ligament comprises a material having orthobiologic properties. This material will help the body's regenerative processes regrow a natural ligament to replace the prosthetic ligament of the present invention.

**[0040]** In some embodiments, the ligament comprises an orthoconductive portion. The orthoconductive portion typically has a porosity (preferably between about 20 mm and 250 mm) that is adapted to allow the ingress of the osteoconductive cells and an internal surface defined by the porosity that is adapted to attach these cells. In some embodiments, the orthoconductive portion comprises subintestinal submucosa (SIS).

**[0041]** In some embodiments, the ligament comprises

an orthoinductive portion. The orthoinductive portion is preferably a protein, and is more preferably a growth factor. Preferred growth factors include factors from the TGF-beta and IGF- families.

**[0042]** In some embodiments, the ligament comprises an orthogenetic portion. The orthogenetic portion preferably comprises mesenchymal stem cells. More preferably, the MSCs are present in a concentration greater than that present in the patient's natural bone marrow.

**[0043]** In some embodiments, only the intermediate portion of the ligament comprises an orthobiologic material. In some embodiments, only the attachment end portion of the ligament comprises an orthobiologic material. In other embodiments, each of the intermediate and attachment end portions of the ligament comprises an orthobiologic material.

**[0044]** Preferably, the ligament is provided in a sterile form. In some embodiments, the ligament is sterilised, and then placed in a package. Preferably, the inside surface of the package is also sterile.

**[0045]** In some embodiments, the intermediate portion of the ligament is tensionable. A tensionable ligament sags when the ends of the ligaments are moved sufficiently closed to one another so that length of the ligament is less the distance between its ends. This quality allows the opposing facets to move closer to each other under loads without resistance from the ligament. A tensionable ligament also becomes taut when its ends are moved sufficiently away from one another so that length of the ligament is about equal to the distance between its ends. This quality constrains relative movement between the opposing facets.

**[0046]** In some embodiments, the tensibility of the ligament is between 10 and 50 N.mm<sup>-1</sup>.

**[0047]** In other embodiments, the ligament is not tensionable.

**[0048]** In some embodiments, at least a portion of the intermediate portion of the ligament is extensible. An extensible ligament has a first at-rest length when its ends are not loaded, and a second larger length when the ligament is subjected to tensioning. This quality allows the ligament to "give" a predetermined amount under tension. This quality is advantageous because the natural facet joint ligament is also extensible. Preferably, the ligament has an extensibility of between 45% and 65% of the at rest length of the ligament when subjected to a load of about 250 N.

**[0049]** In some embodiments, the extensibility of the ligament is between 30 and 70 N.mm<sup>-1</sup>.

**[0050]** In other embodiments, the ligament is not extensible.

**[0051]** In some embodiments, at least a portion of the intermediate portion of the ligament is flexible. A flexible ligament bows under axial loading/easily bends under physiologic flexural loading and easily regains its shape when the loading is ceased. This quality allows the ligament to relax or stretch by a small predetermined amount while transferring stress under axial loading.

This quality is advantageous because the natural facet joint ligament is also flexible. Preferably, the flexible portion of the ligament comprises a curved portion.

**[0052]** Now referring to FIGS. 5-8, there are provided some preferred embodiments of the ligament invention.

**[0053]** Now referring to FIG. 5, in some embodiments, at least a portion of the ligament comprises a curved, flexible intermediate portion 61.

**[0054]** Now referring to FIG. 6 in some embodiments, at least a portion of the ligament comprises a spring 65. The spring quality allows the ligament to initially yield to and eventually resist an axial compressive or tension load. In some embodiments, the spring is an expansion spring. In other embodiments, the spring is a compression spring.

**[0055]** In some embodiments, the intermediate portion of the ligament comprises a first 71 and second 73 intermediate portions bonded together. For example, now referring to FIG. 7, there is provided an embodiment of the ligament of the present invention comprising a pair of curved, flexible intermediate portions encapsulated in an encapsulant 75 (such as a polymer), wherein the ligament is adapted to attach across a facet joint. The advantage of this embodiment is its ability to provide elastic resistance to loads in a plurality of directions and its ability to resist substantial tensile forces due to interlocking members.

**[0056]** Now referring to FIG. 8, there is provided an embodiment of the ligament of the present invention comprising a pair of straight intermediate portions 81, 83 attached by a bonding material 85 (such as a polymer), wherein the ligament is attached across a facet joint. The advantage of this embodiment is its simple design and small size.

**[0057]** In embodiments to be used in the lumbar spine, the ligament of the present invention preferably has a length of between about 1 cm and about 4 cm. It preferably has a width of between about 0.5 cm and about 1 cm.

**[0058]** In some embodiments, the ligament comprises a sheath. In these embodiments, the width of the sheath is much greater. In preferred sheaths, the sheath is sized approximately to enclose the facet joint. In some embodiments, the sheath is fluid permeable. This feature permits the ingress of fluids that help lubricate the joint, while preventing the egress of wear debris from the facet joint articulation surfaces. In some embodiments, the sheath contains a lubricating fluid, thereby imitating a natural facet joint capsule. In preferred embodiments, the sheath may be pre-assembled prior to implantation, or it may be attached via glues, sutures, wires, thermally activated coagulation or *in situ* polymer embedding.

**[0059]** As noted above, in some embodiments, the attachment end portions of the facet joint ligament comprise a pair of fasteners. The function of the fastener is to join to attachment surfaces located on either side of the facet joint in order to securely fasten the intermedi-

ate portion of the facet joint ligament across the facet joint. The fastener may be adapted to fasten the facet joint ligament to attachment surfaces located upon either:

- (a) a facet joint prosthetic component, or
- (b) a bony surface located adjacent the facet joint prosthetic component.

**[0060]** The attachment end portions of the prosthetic ligament of the present invention may be attached to any two anchoring surfaces on opposite sides of the facet joint, provided the ligament traverses the facet joint. These anchoring surfaces may be located on a bony surface of the opposing vertebrae, or on other prosthetic facet joint components.

**[0061]** In one embodiment, the first attachment end portion of the ligament is adapted to attach to a first load-bearing portion of a facet joint prosthesis. This embodiment is surgeon friendly in that the attachment can be made by the manufacturer prior to surgery, thereby providing ease of use and repeatability.

**[0062]** In another embodiment, first attachment end portion of the ligament is adapted to attach to a portion of the natural vertebra. In some embodiments thereof, the vertebral body is used as the anchoring surface. In another, the facet portion of the vertebra is the anchoring surface. In other, and now referring to FIG. 15, the spinous process is used as an anchoring surface.

**[0063]** In another embodiment, the first end portion of the ligament is adapted to attach to the transverse process. In another embodiment, the first end portion of the ligament is adapted to attach to the pedicle. In another embodiment, and now referring to FIG. 16, the ligament is wrapped around the facet joint.

**[0064]** The fastener may be any design known in the art, including winged, barbed or screw-in mechanisms. Preferably, the fastener is a barbed anchor, as it prevents pullout and is easily inserted. When the attachment surface is a bony surface, the fastener may be a bone fastener.

**[0065]** Preferably, the ligament and fastener components are pre-connected. That is, the components are physically attached prior to their placement upon the spine. Pre-connected components are advantageous because their secured attachment to each other are guaranteed, and the surgeon need not waste time in making the attachment. Components may be pre-connected by physical locking, physical connection (as in Figure 3) by bonding, or by making the components from the same material and integrally connecting them. When the preconnected components are integrally formed (by, for example, moulding or thermoforming), there is no danger of micromotion. Therefore, in accordance with the present invention, there is provided a facet joint ligament comprising:

- (a) a ligament comprising first and second end por-

tions, and  
(b) first and second fasteners,

wherein the first fastener is pre-connected to the first end portion of the ligament, and the second fastener is pre-connected to the second end portion of the ligament.

**[0066]** Now referring to Figures 3a and 3b, there is provided a facet joint ligament 3 having:

- (i) an intermediate portion 5,
- (ii) first and second end portions 7,9, and
- (iii) first and second conformable portions 11, 13,  
wherein the first conformable portion is disposed between the intermediate portion and the first end portion, and the second conformable portion is disposed between the intermediate portion and the second end portion, and
- (iv) first and second fasteners 15,17,

wherein the first end portion 7 is shaped to cooperatively connect to the first fastener 15, and the second end portion 9 is shaped to cooperatively connect to the second fastener 17.

**[0067]** Now referring to Figure 3c, preferably, the fastener 19 comprises a longitudinal shank 21, an insertion end 23 comprising protrusions 25 laterally extending from the shank, and an attachment end 27 having an upper surface 31 for connecting to the ligament.

**[0068]** Preferably, the lateral protrusions have leading edges 28 which define an angle  $\alpha$  of no more than  $45^\circ$  relative to the axis of the shank. In such embodiments, the bearing of the leading edge against the vertebral body surface will not substantially impede the progress of the bone fastener into the bone. Preferably, the leading edges define an angle of no more than  $30^\circ$ , and more preferably between about  $20^\circ$  and  $30^\circ$ . When the angle  $\alpha$  is between  $20^\circ$  and  $30^\circ$ , the angle is sufficiently small to not impede the progress of the bone fastener, and yet sufficiently large to insure its secure fit.

**[0069]** In some embodiments, the height H of the protrusions on the bone fastener is no more than 70% of the diameter D of the longitudinal shank. When this condition is selected, the risk that any protrusion will act as a shoulder and stop further entry of the bone fastener into the vertebra is minimised. Preferably, the H/D ratio is no more than 40%, more preferably between about 20% and 40%. Within this more preferred window, the protrusion height is sufficiently small to not impede the progress of the bone fastener, and yet sufficiently large to insure its secure fit.

**[0070]** The outer diameter  $(2H+D)$  of the bone fastener is preferably between about 3 to 9 mm, more preferably about 4 to 6 mm. The length  $L_{BF}$  of the bone fastener is preferably between about 3 to 45 mm, more preferably between about 15 to 25 mm.

**[0071]** In some embodiments, the attachment end of the bone fastener is made of a ceramic material. When

the bone fastener is ceramic, it can withstand the high impact of the driver without failing. Therefore, in accordance with the present invention, there is provided an facet joint ligament comprising:

- (a) a compressible intermediate portion comprising first and second end portions, and
- (b) first and second fasteners, each fastener having an attachment end comprising a ceramic material and a shank comprising a polymer material.

**[0072]** In some embodiments, at least the end portions of the intermediate portion and the attachment end of the bone fastener are made of the same material. When the materials are so selected, these portions may be easily made and pre-connected in an integral fashion. This feature also eliminates the need for sutures.

**[0073]** Referring back to FIG 3c, in another aspect of the present invention, the attachment end 27 of the fastener is configured to accept a driver element. When this configuration is selected, the bone fastener may be driven into the bone by simply providing axial force to the upper surface 31 of the fastener through the driver. Therefore, in accordance with the present invention, there is provided a facet joint ligament comprising:

- (a) a ligament comprising first and second end portions, and
- (b) first and second fasteners,

wherein the first bone fastener is connected to the first end portion of the ligament, and the second bone fastener is connected to the second end portion of the ligament, and

wherein the first bone fastener is configured to accept a driver.

**[0074]** Preferably, the configuration defines a recess 29 upon the upper surface 31 of the attachment end 27 of the fastener. This recess 29 is configured to accept the driver (not shown).

**[0075]** In some embodiments, the recess 29 of the bone fastener may be configured to allow insertion of a rescue screw, thereby allowing retrieval of the bone fastener.

**[0076]** Now referring to Figure 4, in some embodiments, the system has a port for accepting a driver 51 which drives the bone fastener into the vertebral body. In Figure 4, the port comprises a recess 29. In some embodiments, the end portion 53 of intermediate portion is moulded to the upper surface 31 of the attachment end 27 of the fastener such that an insertion tip 59 of driver 51 can be inserted into the recess 29 without damaging the ligament. Figure 4 illustrates such an attachment wherein the end portion 53 of the intermediate portion is attached semi-circumferentially to the outer edge 55 of the upper surface 31 of the fastener. It is appreciated that other embodiments may function similarly, such as attaching the intermediate portion of the liga-

ment to one half face of the fastener upper surface 31 and modifying the driver shoulder to contact the other half face of the fastener surface. Furthermore, the lower surface 57 of the driver shoulder is able to contact the upper surface 31 of the bone fastener. Preferably, the lower surface 52 of the insertion tip 59 is also able to contact the bottom 30 of the fastener recess 29. With these features, the driver can be used to fully seat the fastener in the bony attachment surface and apply pre-tension to the ligament. When the diameter of recess 29 is substantially equal to the diameter of tip 59, the insertion tip will temporarily reinforce the fastener during the insertion step.

**[0077]** In some embodiments, the lower surface 30 of the recess is located at a depth such that both the distal end of tip 59 and shoulder 59 will respectively contact the lower surface 30 (as shown in Figure 3c) and upper surface 31 of the recess.

**[0078]** In some embodiments, the ligament of the present invention is adapted to replace the natural interspinous or intertransverse ligament. In other embodiments, the ligament of the present invention is adapted to replace the facet joint capsule.

**[0079]** In many embodiments, the attachment end portions of the ligament of the present invention are attached to the anchoring surfaces on opposite sides of the facet joint in order to constrain the relative movement of the facets.

**[0080]** As noted above, the facet joints are diarthroidal joints that provide both sliding articulation and load transmission features. The facet's articular surfaces contact in extension, limiting rotation and increasing compressive load.

**[0081]** Preferably, the facet joint ligament of the present invention will be used in conjunction with other prosthetic components designed to mimic the load-bearing and preferably the sliding articulation functions of the natural facet joint. Therefore, in accordance with the present invention, now referring to FIGS. 9 and 10, there is provided a facet joint prosthesis for replacing a natural facet joint comprising first and second facets, the prosthesis comprising:

- (a) a superior facet joint component 91 having an outer surface 93 adapted to attach to a superior facet,
- (b) an inferior facet joint component 95 having an outer surface 97 adapted to attach to an inferior facet,
- (c) a facet joint ligament 99 adapted to constrain relative movement between the superior and inferior facets.

**[0082]** In some embodiments, superior and inferior facet joint components such as those disclosed in the Fitz I, Fitz II, Zuchermann and Martin documents mentioned above can be used.

**[0083]** In embodiments of the present invention com-

prising a prosthesis having superior and inferior facet joint components, the outer surfaces thereof may comprise an attachment feature. Preferred attachment features are selected from the group consisting of teeth, keels, spikes, pins, and combinations thereof. In some embodiments, the outer surface is shaped to conform to the natural facet surface, that is, convex.

**[0084]** Now referring to FIG. 9, in some embodiments of the present invention, the superior and inferior facet joint components of the prosthesis are independent bodies. In preferred embodiments thereof, the superior facet joint component forms a superior endplate having an outer surface adapted to attach to a first facet and an inner articulation surface, while the inferior facet joint component forms an inferior endplate having an outer surface adapted to attach to an inferior facet and an inner articulation surface. In this embodiment, the inner articulation surfaces are adapted to form an articulation interface. For the purposes of the present invention, this embodiment is called an "articulation prosthesis".

**[0085]** In some articulation embodiments, the first inner articulation surface is convex shaped, while the second inner articulation surface is concave shaped. This creates a ball and socket joint well known in the art.

**[0086]** In some embodiments, the first and second articulation surfaces are conforming. In others, the first and second articulation surfaces are non-conforming.

**[0087]** Now referring to FIG. 10, in other embodiments, the superior and inferior facet joint components do not have inner articulation surfaces, but rather are joined by an elastic cushion core. In preferred embodiments thereof, the "cushion-type" prosthesis comprises:

- (a) a superior facet joint component 201 forming a superior endplate having an outer surface 203 adapted to attach to a superior facet and an inner surface 205,
- (b) an inferior facet joint component 211 forming an inferior endplate having an outer surface 213 adapted to attach to an inferior facet and an inner surface 215,
- (c) an elastic core 221 having a superior surface 223 adapted to attach to the inner surface of the superior facet joint component and an inferior surface 225 adapted to attach to the inner surface of the inferior facet joint component.

**[0088]** For the purposes of the present invention, this embodiment is called a "cushion prosthesis". In preferred embodiments thereof, the device comprises an elastomer adapted to elastically compress during axial loading and relax when the load is lifted.

**[0089]** The superior and inferior facet joint components of the present invention may be made from any material appropriate for human surgical implantation, including but not limited to all surgically appropriate metals including titanium, titanium alloy, chrome alloys and stainless steel, and non-metallic materials such as car-



bon fibre materials, resins, plastics and ceramics.

**[0090]** The elastic core may comprise polyurethanes, foamed polyethylene, silicones, rubbers, copolymers or hydrogels. In other embodiments, the elastic core is formed of an orthobiologic material such as hyaluronate, collagen or subintestinal submucosa.

**[0091]** In some embodiments of the present invention having both a pair of prosthetic facet joint articulating surfaces and a prosthetic facet joint ligament, the invention limits the natural spinal extension. In these embodiments, extension is limited to no more than 7°, preferably no more than 5°. Preferably, the device stiffness is at least 2 N.m.(degree)<sup>-1</sup> in order to so limit the extension.

**[0092]** In some embodiments of the present invention having both a pair of prosthetic facet joint articulating surfaces and a prosthetic facet joint ligament, the invention limits the axial compression of the prosthetic articulating surfaces. In these embodiments, axial compression is limited to between 0.1 mm and 2 mm, and is preferably between 0.5 and 1.5 mm. In this preferred range, the axial compression is similar to that of the natural healthy facet joint.

**[0093]** In some embodiments of the present invention having a prosthetic facet joint ligament, the invention resists flexion. In these embodiments, flexion is limited to no more than 15°, and preferably is no more than 12°. Preferably, the tensile strength of the prosthetic capsule is between 50 and 300 N, is preferably at least 100 N, and is more preferably at least 200 N.

**[0094]** In some embodiments of the present invention having both a pair of prosthetic facet joint articulating surfaces and a prosthetic facet joint ligament, the invention resists axial rotation. In these embodiments, a pair of devices of the present invention are preferably used so that each facet joint of a functional spine unit has a device, whereby a first device limits the axial rotation while the ligament of the second device is put in tension. This motion tends to produce coupled motion with flexion and bending. In some embodiments, the prosthetic articulating surfaces of the first device are sufficiently strong to withstand compressive forces of at least 100 N, and more preferably at least 150 N, and more preferably at least 200 N.

**[0095]** In some embodiments of the present invention having both a pair of prosthetic facet joint articulating surfaces and a prosthetic facet joint ligament, the invention resists at least anterior-posterior shear. In these embodiments, the prosthetic articulating surfaces contact and the prosthetic articulating surfaces are sufficiently strong to withstand contact shear forces of at least 500 N, and more preferably at least 750 N, and more preferably at least 1000 N.

**[0096]** In some preferred embodiments, at least one prosthetic facet joint component is used in conjunction with an anterior-based intervertebral body device. Preferably, the at least one prosthetic facet joint component is selected from the group consisting of the superior fac-

et joint component, the inferior facet joint component, and the facet joint ligament, and combinations thereof.

**[0097]** Preferably, the intervertebral body device is selected from the group consisting of:

- (a) an interbody fusion device, and
- (b) a motion device.

**[0098]** Preferred motion devices are selected from the group consisting of articulating devices, cushion devices, nucleus pulposus replacements and devices comprising a compound adapted to promote nucleus pulposus regeneration ("orthobiologic disc device").

**[0099]** Preferred interbody fusion devices are disclosed in US-4834757 (Brantigan), and US-5489308 (Kuslich).

**[0100]** Now referring to FIG. 11, there is provided:

(a) an artificial interbody spinal fusion implant for insertion within an implantation space formed across the height of a disc space between vertebral bodies of a human spine, the vertebral bodies having an anterior aspect and a posterior aspect and a depth between them, said implant comprising;

a leading end 353 for insertion first into the disc space and a trailing end 355 opposite said leading end, said implant having a length from said leading end to said trailing end;

a top 357 and a bottom 359 between said leading and trailing ends adapted to space apart the adjacent vertebral bodies, said top and said bottom each preferably having at least one opening 361 extending through them, said openings being in communication with one another to permit for the growth of bone from adjacent vertebral body to adjacent vertebral body through said implant, said implant having a height H from said top to said bottom;

opposite sides between said top and said bottom, and between said leading and trailing ends, said implant having a width W from one of said sides to the other of said sides, the height of said implant preferably being less than the width of said implant;

said implant being formed at least in part of a material other than bone; and

said implant being configured to be wholly contained within the perimeter of the adjacent vertebral bodies, and

(b) a facet joint ligament.

**[0101]** Preferred articulating motion devices are disclosed in US-5556431 and US-5674296.

**[0102]** Now referring to FIG. 12, in some embodiments, the articulating motion disc is a three piece design. Thus, the invention comprises:

a motion disc comprising:

- (a) a first prosthetic vertebral endplate

comprising:

- (i) an outer surface 373 adapted to mate with a first vertebral body,
- (ii) an inner surface 375 having a first articulation surface 377,
- (iii) a body portion 379 connecting the inner and outer surfaces,

(b) a second prosthetic vertebral endplate 381 comprising:

- (i) an outer surface 383 adapted to mate with a second vertebral body, and
- (ii) an inner surface 385 comprising a first articulation surface 387,

(c) a core member 391 comprising:

- (i) a first articulation surface 393 adapted for articulation with the first articulation surface of the first endplate, and
- (ii) a second articulation surface 395 adapted for articulation with the first articulation surface of the second endplate,

wherein the core member is oriented to produce a first articulation interface between the first articulation surface of the first endplate and the first articulation surface of the core member, and a second articulation interface between the first articulation surface of the second endplate and the second articulation surface of the core member, and a facet joint ligament.

**[0103]** Now referring to FIG. 13, in some embodiments, the articulating motion disc is a two piece design. Thus, the invention comprises:

a motion disc 401 comprising:

(a) a first prosthetic vertebral endplate 431 comprising:

- (i) an outer surface 433 adapted to mate with a first vertebral body,
- (ii) an inner surface 435 having a first articulation surface 441,
- (iii) a body portion 443 connecting the inner and outer surfaces,

(b) a second prosthetic vertebral endplate 411 comprising:

- (i) an outer surface 413 adapted to mate with a second vertebral body, and
- (ii) an inner surface 415 comprising a second articulation surface 417,

wherein the first and second articulation surfaces are oriented produce an articulation interface, and a facet joint ligament.

**[0104]** Other preferred articulating motion devices are disclosed in US-6368350 and US-5507816.

**[0105]** Preferred cushion motion devices are disclosed in US-6136031, US-5071437 and US-5645597.

**[0106]** Now referring to FIG. 14, in some embodiments, the motion disc is a cushion disc and the invention comprises:

a cushion motion disc comprising:

(a) a first prosthetic vertebral endplate 451 comprising:

- (i) an outer surface 453 adapted to mate with a first vertebral body,
- (ii) an inner surface 455,
- (iii) a body portion 453 connecting the inner and outer surfaces,

(b) a second prosthetic vertebral endplate 461 comprising:

- (i) an outer surface 463 adapted to mate with a second vertebral body, and
- (ii) an inner surface 465,

(c) a core cushion member 471 comprising:

- (i) a first attachment surface 473 adapted for attachment to the first articulation surface of the first endplate, and
- (ii) a second attachment surface 475 adapted for articulation with the first articulation surface of the second endplate, and
- (iii) an elastic body portion 479 connecting the first and second attachment surfaces of the core cushion member.

**[0107]** Preferred nucleus pulposus replacement devices are disclosed in US-5976186, US-5674295 and US-6264695.

**Claims**

1. A prosthetic facet joint ligament.
2. The ligament of claim 1 wherein the ligament is lubricated.
3. The ligament of claim 1 wherein the ligament comprises an orthoconductive portion.

4. The ligament of claim 3 wherein the orthoconductive portion comprises SIS.
5. The ligament of claim 1 wherein the ligament comprises an orthoinductive portion. 5
6. The ligament of claim 5 wherein the orthoinductive portion comprises a growth factor.
7. The ligament of claim 1 wherein the ligament comprises an orthogenic portion. 10
8. The ligament of claim 7 wherein the orthogenic portion comprises concentrated MSCs.
9. The ligament of claim 1 wherein the ligament comprises an intermediate elastic portion. 15
10. The ligament of claim 9 wherein the intermediate elastic portion comprises a polymer or a rubber. 20
11. The ligament of claim 1 wherein the ligament is braided.
12. The ligament of claim 1 comprising an expansion spring or a compression spring. 25
13. The ligament of claim 1 comprising a sheath adapted to enclose a facet joint. 30
14. The ligament of claim 13 wherein the sheath encloses a fluid or is permeable to a fluid.
15. The ligament of claim 1 having a flexible portion which preferably is curved. 35
16. The ligament of claim 1 being inflexible.
17. The ligament of claim 1 having an extensible portion. 40
18. The ligament of claim 1 being inextensible.
19. The ligament of claim 1 having an attachment end portion. 45
20. The ligament of claim 1 adapted to wrap around a facet joint.
21. A facet joint prosthesis for replacing a natural facet joint comprising first and second facets, the prosthesis comprising: 50
- (a) a superior facet joint component having a superior outer surface adapted to attach to a superior facet, 55
  - (b) an inferior facet joint component having an inferior outer surface adapted to attach to an inferior facet, and
  - (c) a ligament adapted to constrain relative movement between the facets.
22. The prosthesis of claim 21 wherein the superior and inferior components are integral.
23. The prosthesis of claim 22 wherein the superior and inferior components form an interbody fusion device.
24. The prosthesis of claim 21 wherein the superior and inferior components are not integral.
25. The prosthesis of claim 21 wherein the ligament comprises a first attachment end portion adapted to attach to a first portion of the superior facet joint component.
26. The prosthesis of claim 21 wherein the ligament comprises a first attachment end portion adapted to attach to a natural vertebra.

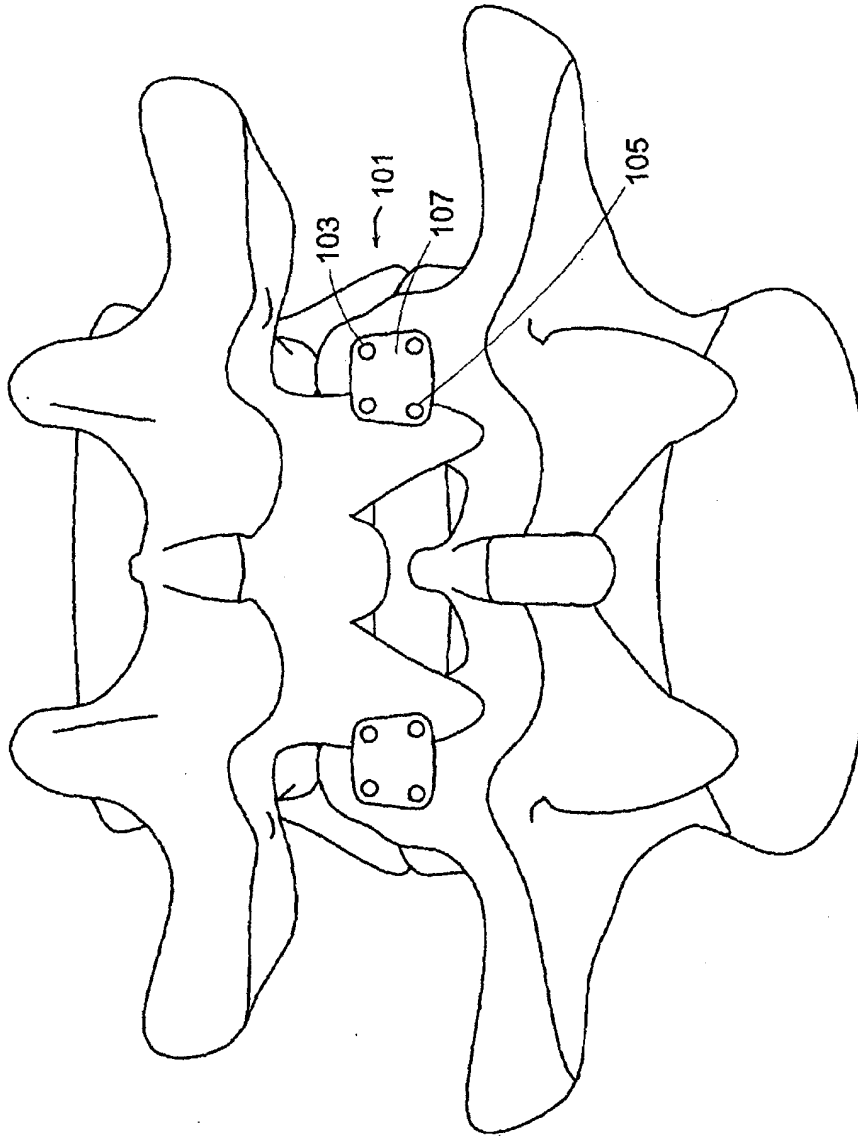

FIG. 1

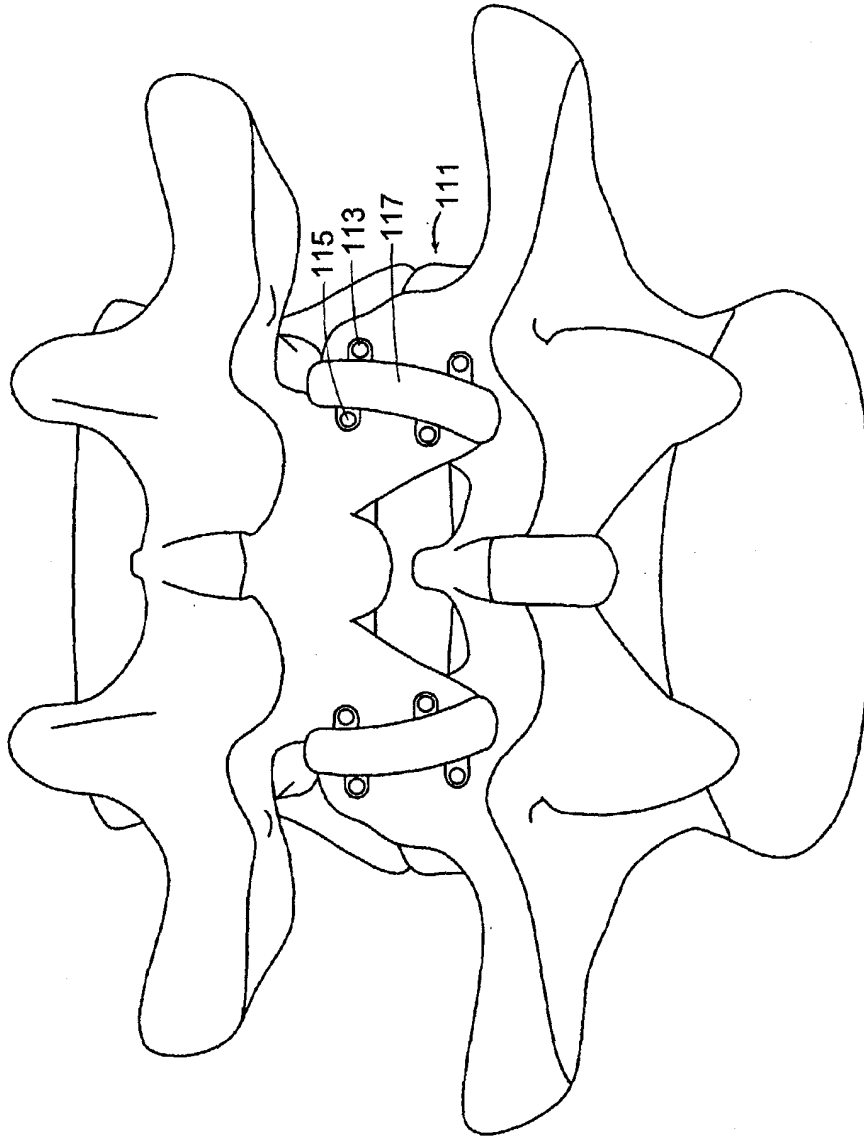

FIG. 2

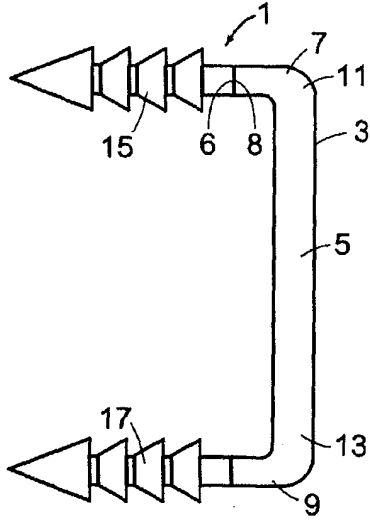

FIG. 3A

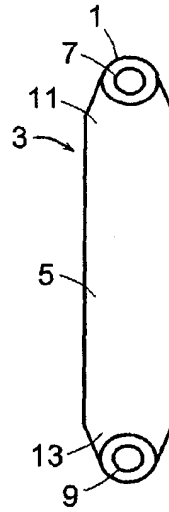

FIG. 3B

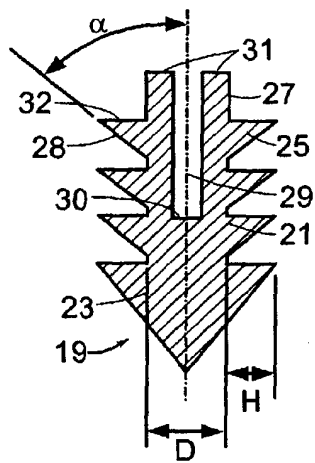

FIG. 3C

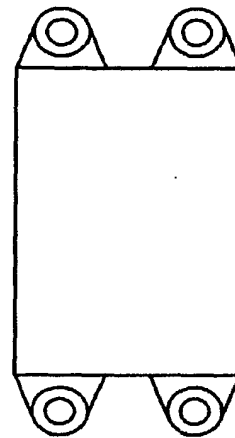

FIG. 3D

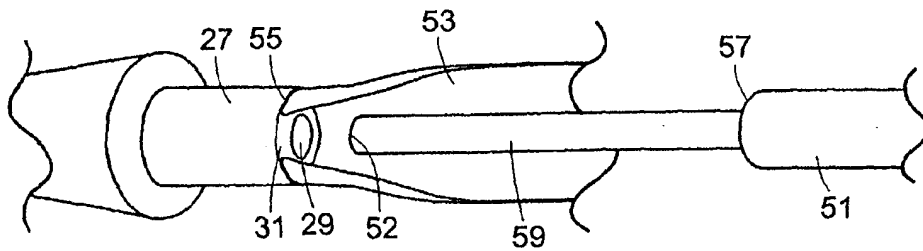

FIG. 4

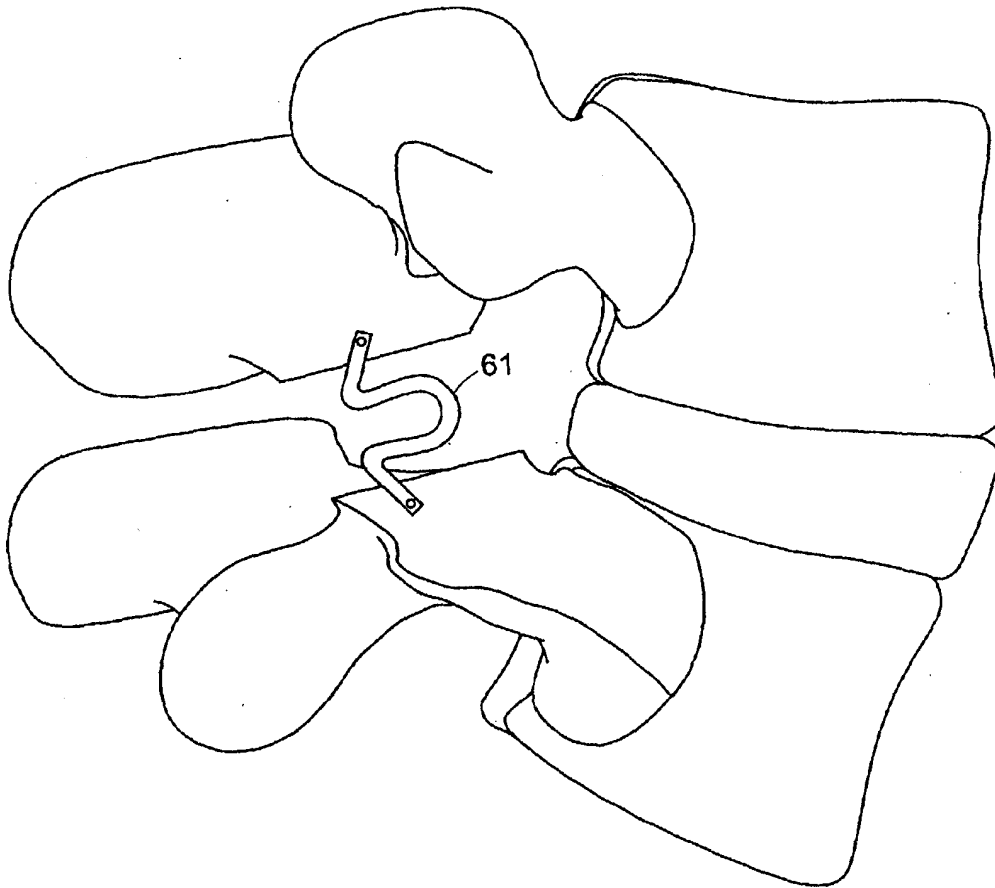

FIG. 5

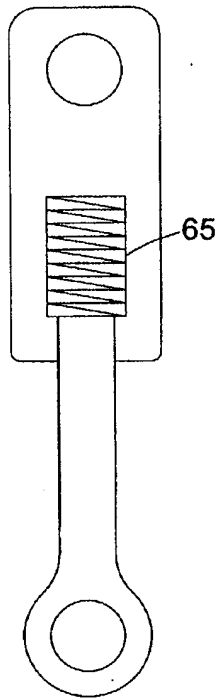

FIG. 6

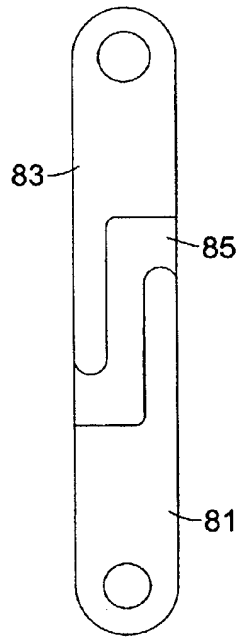

FIG. 8

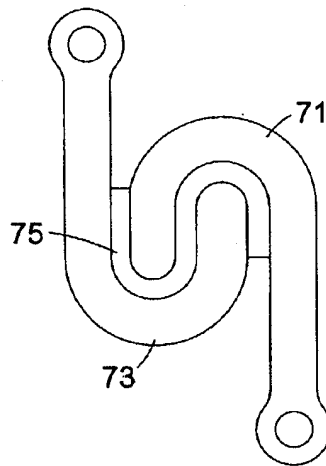

FIG. 7



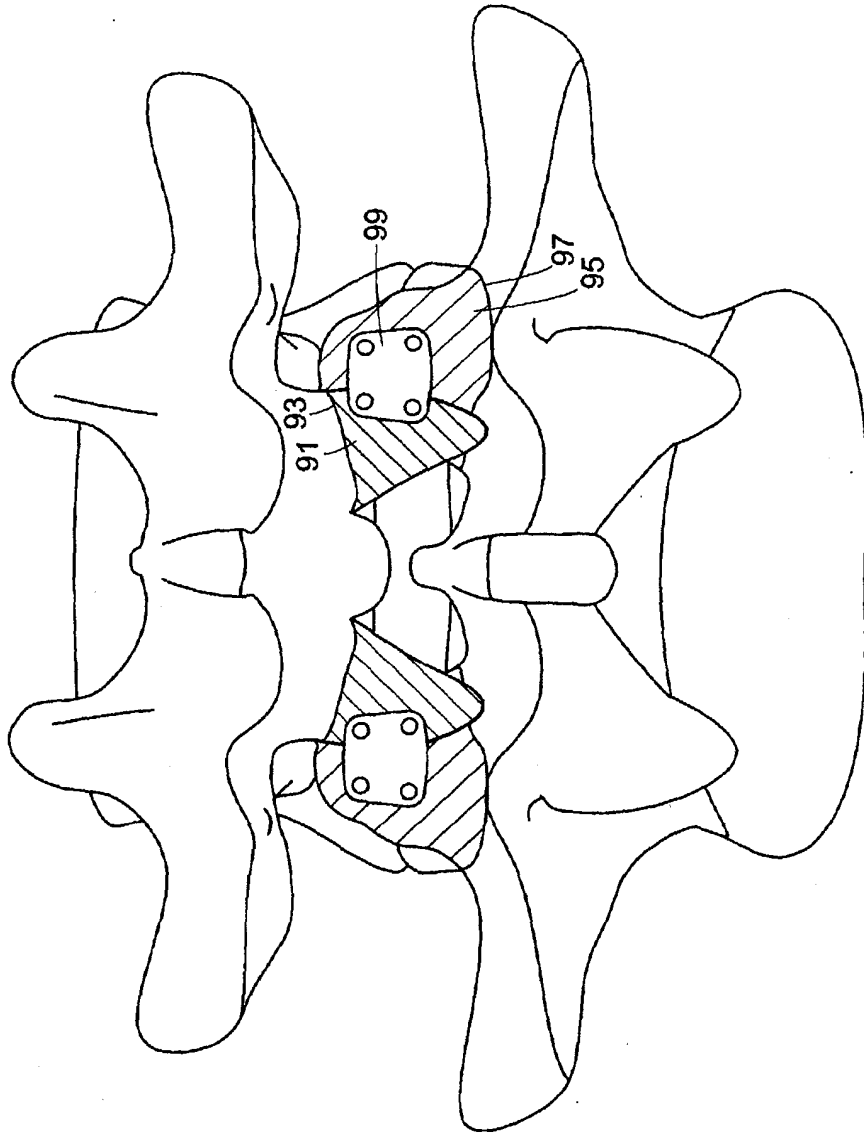

FIG. 9

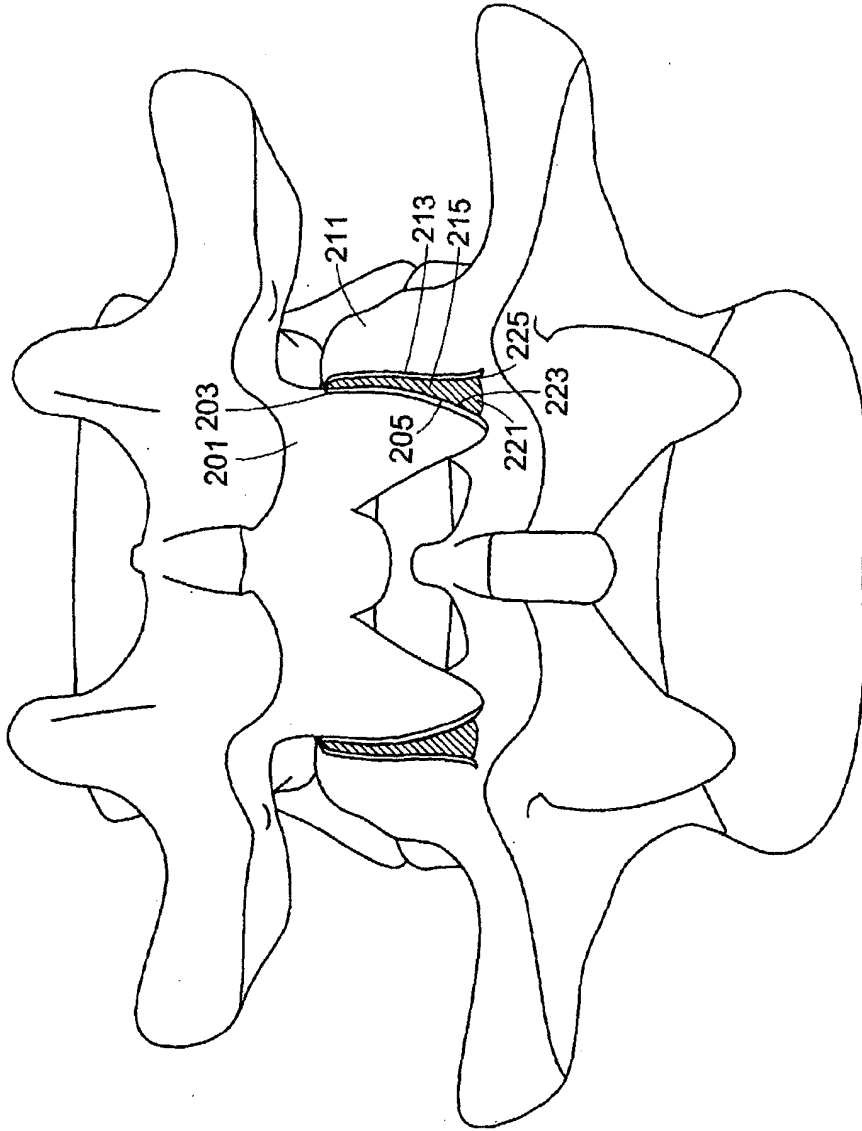

FIG. 10

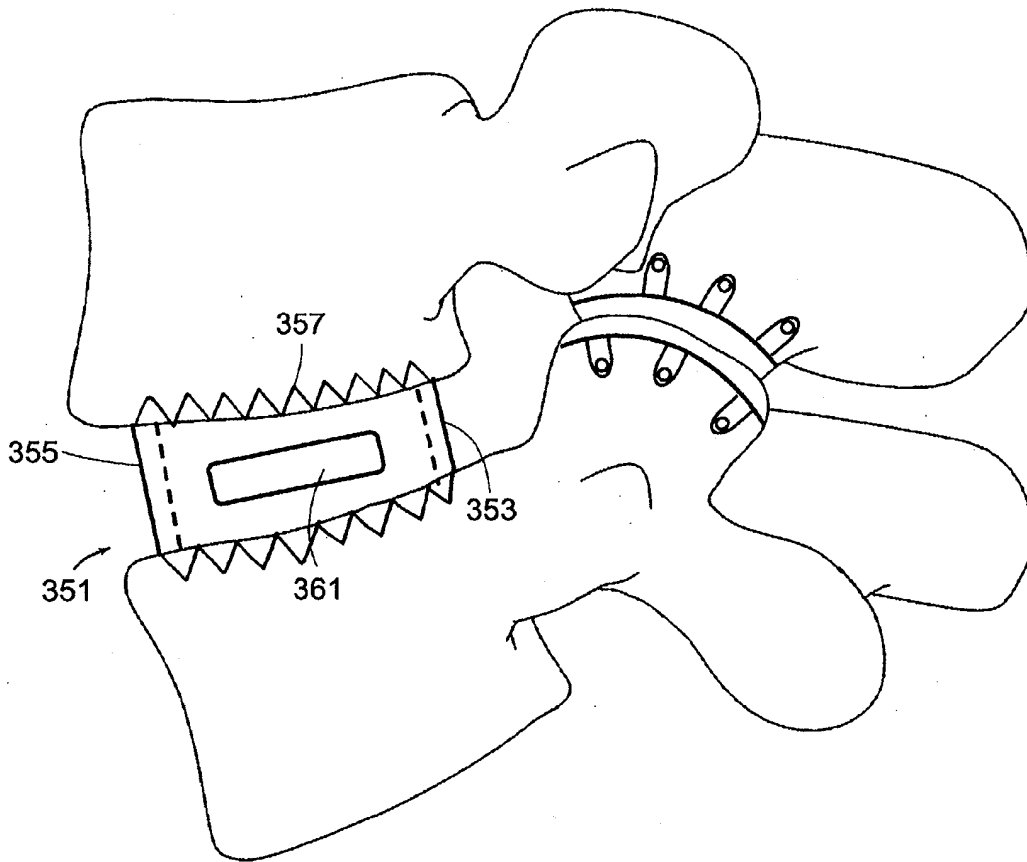

FIG. 11

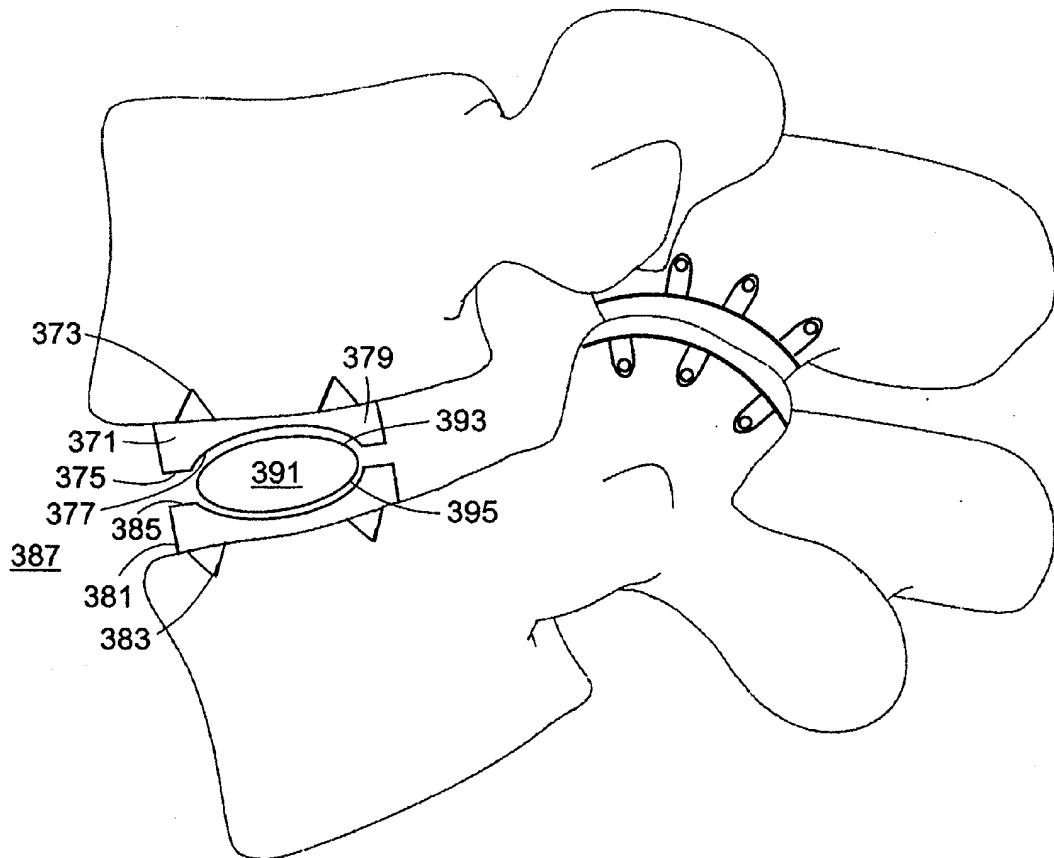

FIG. 12

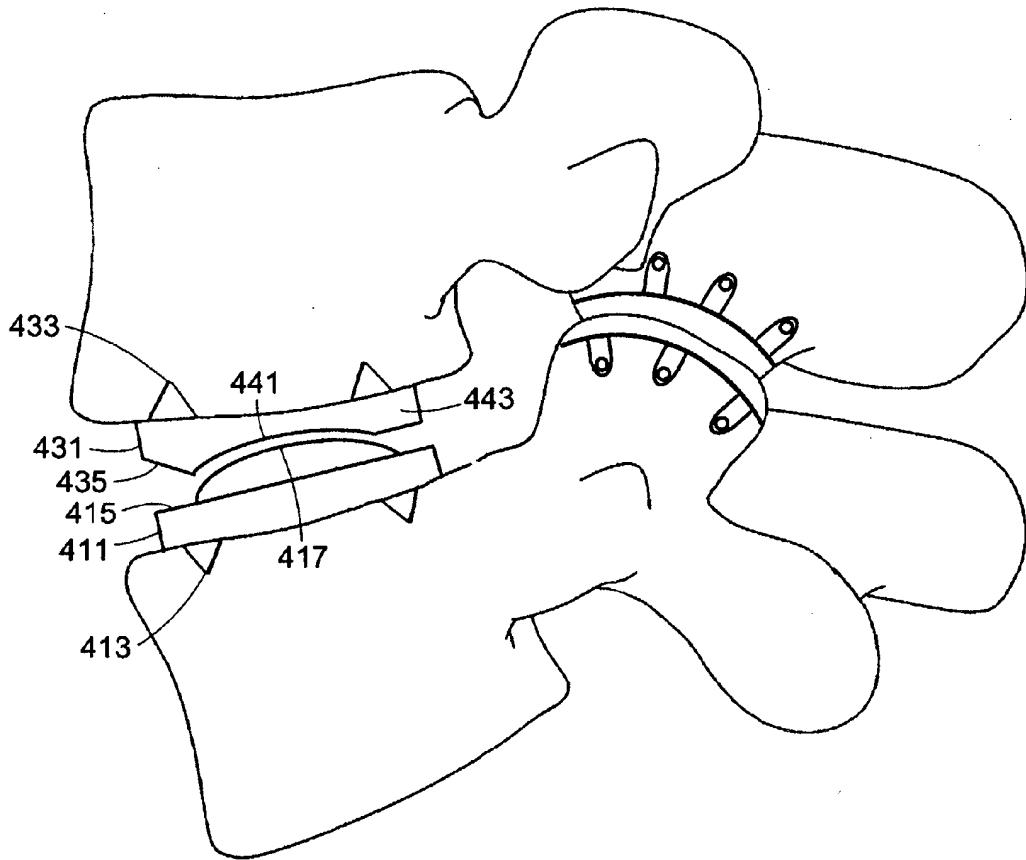

FIG. 13

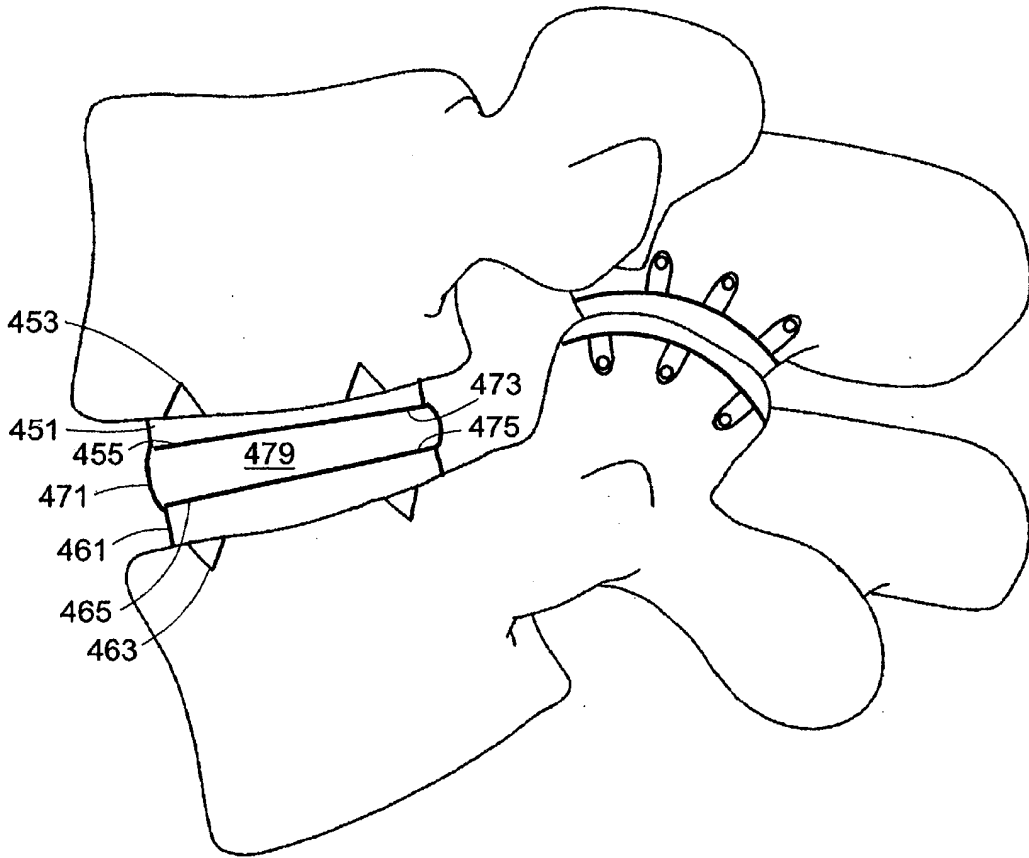

FIG. 14

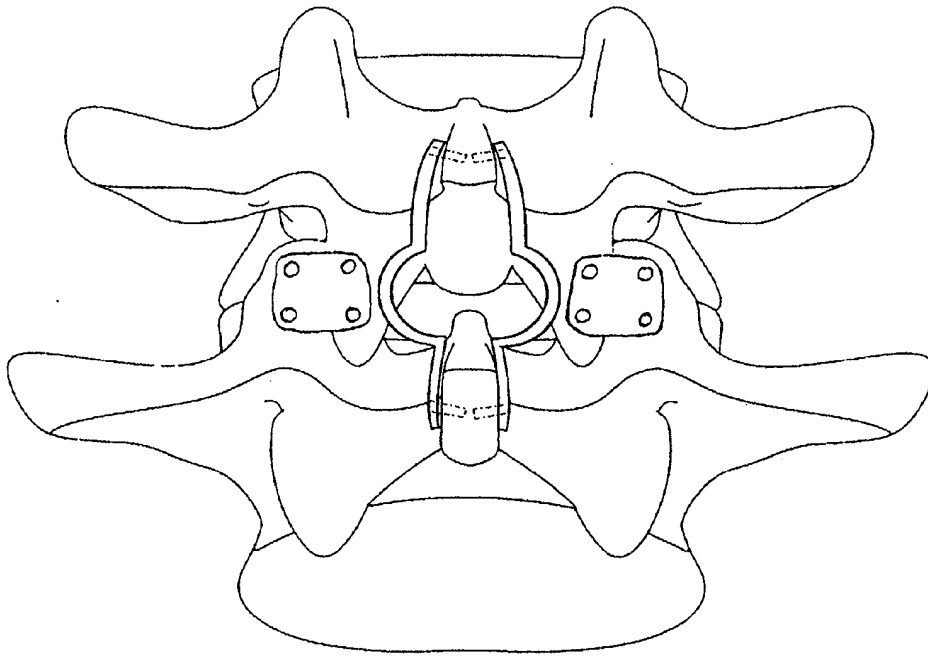

FIG. 15

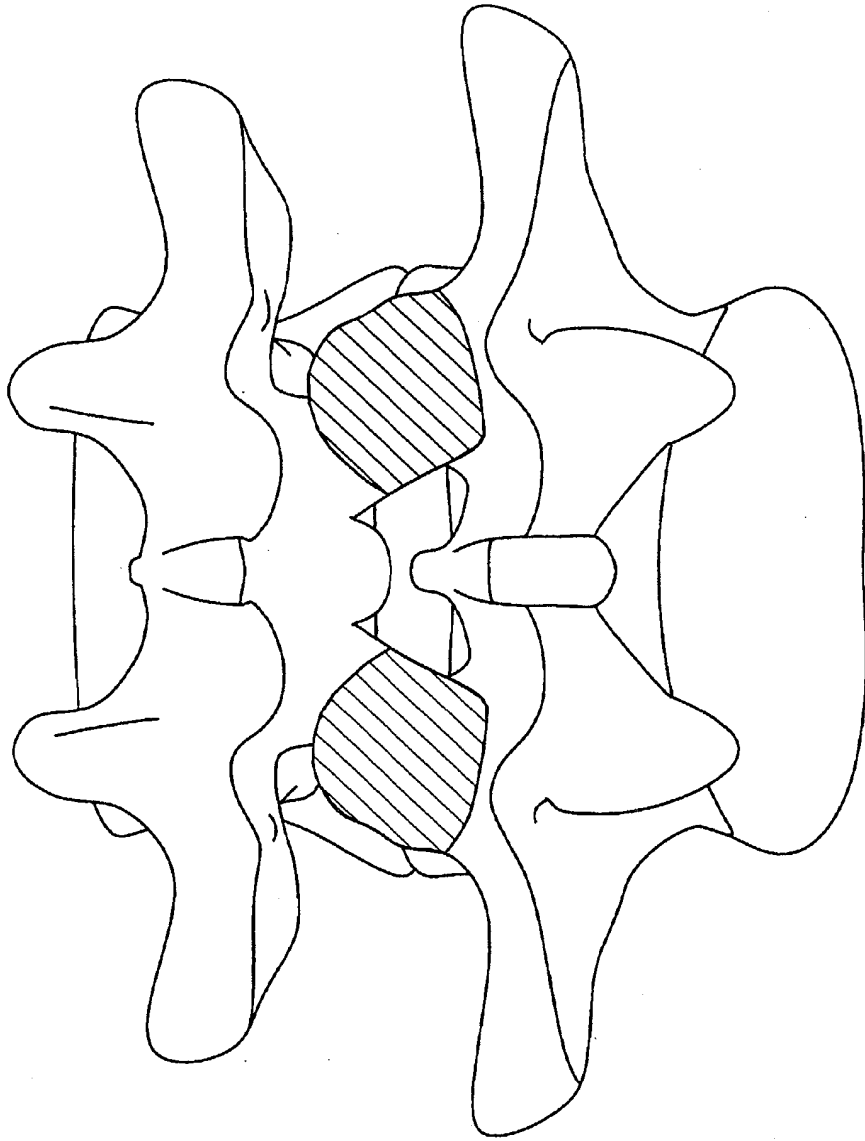

FIG. 16



(19)



Europäisches Patentamt  
European Patent Office  
Office européen des brevets



(11)

**EP 1 437 101 A3**

(12)

**EUROPEAN PATENT APPLICATION**

(88) Date of publication A3:  
**22.12.2004 Bulletin 2004/52**

(51) Int Cl.7: **A61F 2/08, A61F 2/44**

(43) Date of publication A2:  
**14.07.2004 Bulletin 2004/29**

(21) Application number: **03258243.9**

(22) Date of filing: **30.12.2003**

(84) Designated Contracting States:  
**AT BE BG CH CY CZ DE DK EE ES FI FR GB GR  
HU IE IT LI LU MC NL PT RO SE SI SK TR**  
Designated Extension States:  
**AL LT LV MK**

- **Serhan, Hassan A.**  
**South Easton, MA 02375 (US)**
- **Garcia, Mark**  
**Rochester, MA 02770 (US)**

(30) Priority: **31.12.2002 US 334601**

(74) Representative: **Belcher, Simon James**  
**Urquhart-Dykes & Lord LLP**  
**Tower North Central**  
**Merrion Way**  
**Leeds LS2 8PA (GB)**

(71) Applicant: **DePuy Spine, Inc.**  
**Raynham, MA 02767-0350 (US)**

(72) Inventors:  
• **Dooris, Andrew**  
**Fall River, MA 02720 (US)**

(54) **Prosthetic facet joint ligament**

(57) A facet joint prosthesis for replacing a natural facet joint comprising first and second facets, comprises a superior facet joint component having a superior outer surface adapted to attach to a superior facet, an inferior

facet joint component having an inferior outer surface adapted to attach to an inferior facet, and a ligament adapted to constrain relative movement between the facets.

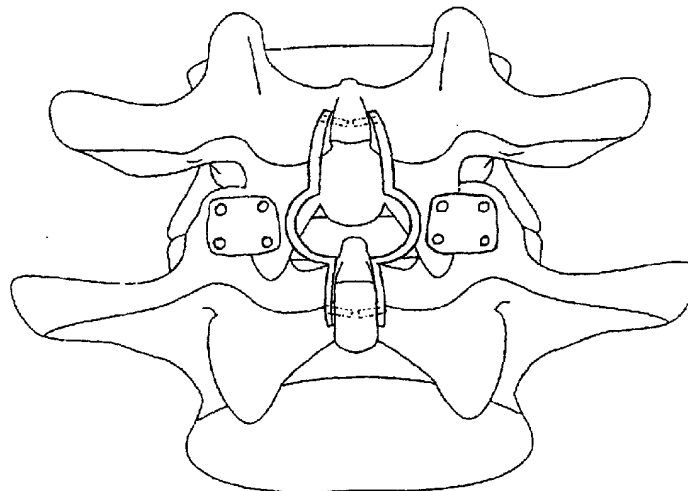

**FIG. 15**

**EP 1 437 101 A3**



European Patent  
Office

EUROPEAN SEARCH REPORT

Application Number  
EP 03 25 8243

DOCUMENTS CONSIDERED TO BE RELEVANT			
Category	Citation of document with indication, where appropriate, of relevant passages	Relevant to claim	CLASSIFICATION OF THE APPLICATION (Int.Cl.7)
X	US 5 263 984 A (LI SHU-TUNG ET AL) 23 November 1993 (1993-11-23) * claim 1; figures 2A,2B,2E * * column 3, line 29 - line 32 * * column 8, line 23 - line 55 * * column 11, line 60 - line 66 * -----	1,2,11, 19,20	A61F2/08 A61F2/44
X	US 5 628 756 A (LANGE ERIC ET AL) 13 May 1997 (1997-05-13) * claims 1,2,11,20; figures 1,5,7,19,20,33-39 * * column 4, line 29 - line 31 * -----	1,2,11, 20	
X	US 4 455 690 A (HOMSY CHARLES A) 26 June 1984 (1984-06-26) * claim 15; figures * -----	1,2,19	
D,X	WO 00/53126 A (OGON MICHAEL ;AESFULAP AG & CO KG (DE); LUTZE THEODOR (DE); WING C) 14 September 2000 (2000-09-14) * claims 1,5; figures * * page 7, paragraph 2 * * page 8, paragraph 3 * -----	1,16,18	TECHNICAL FIELDS SEARCHED (Int.Cl.7)  A61F
X	WO 02/067793 A (SDGI HOLDINGS INC) 6 September 2002 (2002-09-06) * figures 1-4,21,22 * * page 1, line 25 - page 2, line 9 * * page 15, line 2 - line 10 * -----	1	
Y	-----	21-26	
Y	DE 201 12 123 U (AESFULAP AG & CO KG) 27 September 2001 (2001-09-27) * claims 1-3; figures * -----	21-23, 25,26	
-/--			
The present search report has been drawn up for all claims			
Place of search	Date of completion of the search	Examiner	
Berlin	21 October 2004	Stach, R	
CATEGORY OF CITED DOCUMENTS			
X : particularly relevant if taken alone Y : particularly relevant if combined with another document of the same category A : technological background O : non-written disclosure P : intermediate document		T : theory or principle underlying the invention E : earlier patent document, but published on, or after the filing date D : document cited in the application L : document cited for other reasons & : member of the same patent family, corresponding document	

EPO FORM 1503 03/92 (P4/C01)



European Patent Office

EUROPEAN SEARCH REPORT

Application Number  
EP 03 25 8243

DOCUMENTS CONSIDERED TO BE RELEVANT			
Category	Citation of document with indication, where appropriate, of relevant passages	Relevant to claim	CLASSIFICATION OF THE APPLICATION (Int.Cl.7)
Y	US 5 571 191 A (FITZ WILLIAM R) 5 November 1996 (1996-11-05) * claim 1; figures *	24	
A	-----	21	
A	WO 02/065954 A (BORSCHNECK DANIEL P ; SAUNDERS GERALD A B (CA); UNIV KINGSTON (CA); SO) 29 August 2002 (2002-08-29) * figures 3c-3f, 7b * * page 7, line 9 - line 28 *	21-23	
A	US 2002/065557 A1 (FALLIN T WADE ET AL) 30 May 2002 (2002-05-30) * claim 13; figures *	21,24	
			TECHNICAL FIELDS SEARCHED (Int.Cl.7)
The present search report has been drawn up for all claims			
Place of search		Date of completion of the search	Examiner
Berlin		21 October 2004	Stach, R
CATEGORY OF CITED DOCUMENTS			
X : particularly relevant if taken alone Y : particularly relevant if combined with another document of the same category A : technological background O : non-written disclosure P : intermediate document		T : theory or principle underlying the invention E : earlier patent document, but published on, or after the filing date D : document cited in the application L : document cited for other reasons ..... & : member of the same patent family, corresponding document	

EPO FORM 1503 03/82 (P04/C01)

**CLAIMS INCURRING FEES**

The present European patent application comprised at the time of filing more than ten claims.

- Only part of the claims have been paid within the prescribed time limit. The present European search report has been drawn up for the first ten claims and for those claims for which claims fees have been paid, namely claim(s):
- No claims fees have been paid within the prescribed time limit. The present European search report has been drawn up for the first ten claims.

**LACK OF UNITY OF INVENTION**

The Search Division considers that the present European patent application does not comply with the requirements of unity of invention and relates to several inventions or groups of inventions, namely:

see sheet B

- All further search fees have been paid within the fixed time limit. The present European search report has been drawn up for all claims.
- As all searchable claims could be searched without effort justifying an additional fee, the Search Division did not invite payment of any additional fee.
- Only part of the further search fees have been paid within the fixed time limit. The present European search report has been drawn up for those parts of the European patent application which relate to the inventions in respect of which search fees have been paid, namely claims:
- 1, 2, 11, 16, 18-26
- None of the further search fees have been paid within the fixed time limit. The present European search report has been drawn up for those parts of the European patent application which relate to the invention first mentioned in the claims, namely claims:



The Search Division considers that the present European patent application does not comply with the requirements of unity of invention and relates to several inventions or groups of inventions, namely:

1. claims: 1,2,11,16,18-20

A prosthetic facet joint ligament wherein the ligament is lubricated.

(Problem: lowering the friction coefficient between the ligament and the surrounding tissue in order to lower the wear)

1.1. claims: 16,18

A facet joint ligament being inflexible  
(problem: fixation of the facet joint)

---

2. claims: 3-8

A facet joint ligament wherein the ligament comprises an orthoconductive, orthoinductive or orthogenetic portion.  
(problem: long term stabilization of the ligament in the body after surgery)

---

3. claims: 9, 10, 12, 15, 17

A facet joint ligament wherein the ligament comprises an intermediate elastic portion or spring.  
(problem: providing the artificial ligament with elastic properties that are similar to those of the natural ligament)

---

4. claims: 13, 14

A facet joint ligament comprising a sheath adapted to enclose a facet joint.  
(problem: constraining the relative movement of a facet joint in a plurality of directions)

---

5. claims: 21-26

A facet joint prosthesis comprising  
a superior facet joint component adapted to attach to a superior facet,  
an inferior facet joint component adapted to attach to a inferior facet,  
a ligament adapted to constrain the relative movement between the facets.  
(problem: replacing the surfaces of a damaged natural facet joint)

---



European Patent  
Office

**LACK OF UNITY OF INVENTION  
SHEET B**

Application Number  
EP 03 25 8243

The Search Division considers that the present European patent application does not comply with the requirements of unity of invention and relates to several inventions or groups of inventions, namely:

Please note that all inventions mentioned under item 1, although not necessarily linked by a common inventive concept, could be searched without effort justifying an additional fee.

**ANNEX TO THE EUROPEAN SEARCH REPORT  
ON EUROPEAN PATENT APPLICATION NO.**

EP 03 25 8243

This annex lists the patent family members relating to the patent documents cited in the above-mentioned European search report. The members are as contained in the European Patent Office EDP file on  
The European Patent Office is in no way liable for these particulars which are merely given for the purpose of information.

21-10-2004

Patent document cited in search report		Publication date	Patent family member(s)	Publication date
US 5263984	A	23-11-1993	US 4880429 A	14-11-1989
			US 5007934 A	16-04-1991
			US 5116374 A	26-05-1992
			AU 676832 B2	27-03-1997
			AU 4048493 A	29-11-1993
			CA 2134111 A1	11-11-1993
			DE 69332079 D1	08-08-2002
			DE 69332079 T2	27-02-2003
			DK 639959 T3	28-10-2002
			EP 0639959 A1	01-03-1995
			ES 2174847 T3	16-11-2002
			JP 7505326 T	15-06-1995
			WO 9321857 A1	11-11-1993
			AT 87452 T	15-04-1993
			AU 605723 B2	17-01-1991
			AU 2424588 A	13-02-1989
			DE 3879921 D1	06-05-1993
			DE 3879921 T2	14-10-1993
			EP 0324852 A1	26-07-1989
			JP 2500654 T	08-03-1990
			JP 2754027 B2	20-05-1998
			US 6042610 A	28-03-2000
			WO 8900413 A1	26-01-1989
			US 5624463 A	29-04-1997
			US 5681353 A	28-10-1997
			US 5735903 A	07-04-1998
			US 5735902 A	07-04-1998
			US 5158574 A	27-10-1992
			US 5306311 A	26-04-1994
			US 5258043 A	02-11-1993
			AT 125441 T	15-08-1995
			AU 637605 B2	03-06-1993
			AU 5337990 A	26-09-1990
			CA 2050471 A1	03-09-1990
			DE 69021204 D1	31-08-1995
			DE 69021204 T2	07-12-1995
			EP 0461201 A1	18-12-1991
			ES 2077676 T3	01-12-1995
			JP 4504968 T	03-09-1992
			JP 3100156 B2	16-10-2000
			WO 9009769 A1	07-09-1990
			US 5108438 A	28-04-1992
-----				
US 5628756	A	13-05-1997	US 5540703 A	30-07-1996
			US 5456722 A	10-10-1995
			AU 4505696 A	26-06-1996

EPO FORM P0459

For more details about this annex : see Official Journal of the European Patent Office, No. 12/82

**ANNEX TO THE EUROPEAN SEARCH REPORT  
ON EUROPEAN PATENT APPLICATION NO.**

EP 03 25 8243

This annex lists the patent family members relating to the patent documents cited in the above-mentioned European search report. The members are as contained in the European Patent Office EDP file on  
The European Patent Office is in no way liable for these particulars which are merely given for the purpose of information.

21-10-2004

Patent document cited in search report		Publication date	Patent family member(s)	Publication date
US 5628756	A		WO 9617544 A2	13-06-1996
			AU 5992794 A	15-08-1994
			WO 9415550 A1	21-07-1994
US 4455690	A	26-06-1984	DE 3170332 D1	05-06-1985
			EP 0051954 A2	19-05-1982
WO 0053126	A	14-09-2000	DE 29904271 U1	29-07-1999
			WO 0053126 A1	14-09-2000
WO 02067793	A	06-09-2002	CA 2439525 A1	06-09-2002
			EP 1381322 A1	21-01-2004
			JP 2004527287 T	09-09-2004
			WO 02067793 A2	06-09-2002
			US 2002120270 A1	29-08-2002
DE 20112123	U	27-09-2001	DE 20112123 U1	27-09-2001
US 5571191	A	05-11-1996	US RE36758 E	27-06-2000
WO 02065954	A	29-08-2002	WO 02065954 A1	29-08-2002
			CA 2437575 A1	29-08-2002
			US 2002151895 A1	17-10-2002
US 2002065557	A1	30-05-2002	US 2003191532 A1	09-10-2003